

Bridge Rectifiers

Features

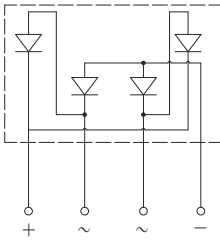
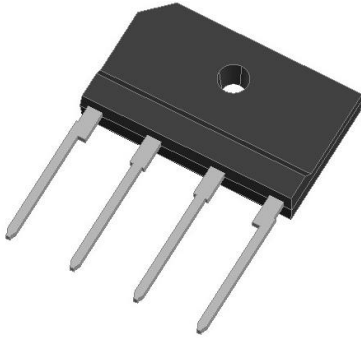
- UL recognition, file #E230084
- Thin single in-line package
- High surge current capability
- Solder dip 275 °C max. 7 s, per JESD 22-B106

Typical Applications

General purpose use in AC/DC bridge full wave rectification for switching power supply, home appliances, office equipment, industrial automation applications.

Mechanical Data

- **Package:** 4KBJ
Molding compound meets UL 94 V-0 flammability rating, RoHS-compliant
- **Terminals:** Tin plated leads, solderable per J-STD-002 and JESD22-B102
- **Polarity:** As marked on body



■ Maximum Ratings ($T_a=25^\circ\text{C}$ Unless otherwise specified)

PARAMETER	SYMBOL	UNIT	KBJ6005	KBJ601	KBJ602	KBJ604	KBJ606	KBJ608	KBJ610
Device marking code			KBJ6005	KBJ601	KBJ602	KBJ604	KBJ606	KBJ608	KBJ610
Repetitive Peak Reverse Voltage	VRRM	V	50	100	200	400	600	800	1000
Average Rectified Output Current @60Hz sine wave, R-load,	With heatsink $T_c=110^\circ\text{C}$	IO	A	6.0					
	Without heatsink $T_a=25^\circ\text{C}$			2.8					
Surge(non-repetitive)forward current @60Hz half-sine wave, 1 cycle, $T_j=25^\circ\text{C}$	IFSM	A	150						
Current squared time @1ms≤t≤8.3ms $T_j=25^\circ\text{C}$,rating of per diode	I^2t	A^2S	93						
Storage Temperature	T_{stg}	$^\circ\text{C}$	-55 ~+150						
Junction Temperature	T_j	$^\circ\text{C}$	-55 ~+150						
Dielectric strength @ terminals to case, AC 1 minute	Vdis	KV	2						
Mounting torque @recommend torque: 5kg · cm	Tor	kg · cm	8						

■ Electrical Characteristics ($T_a=25^\circ\text{C}$ Unless otherwise specified)

PARAMETER	SYMBOL	UNIT	TEST CONDITIONS	KBJ6005	KBJ601	KBJ602	KBJ604	KBJ606	KBJ608	KBJ610
Maximum instantaneous forward voltage drop per diode	V _F	V	I _{FM} =3.0A	1.00						
Maximum DC reverse current at rated DC blocking voltage per diode	I _{RRM}	μA	V _{RM} =V _{RRM}	5						

Thermal Characteristics ($T_a=25^\circ\text{C}$ Unless otherwise specified)

PARAMETER		SYMBOL	UNIT	KBJ6005	KBJ601	KBJ602	KBJ604	KBJ606	KBJ608	KBJ610
Thermal Resistance	Between junction and ambient, Without heatsink	$R_{\theta J-A}$	$^\circ\text{C/W}$	26.0						
	Between junction and case, With heatsink	$R_{\theta J-C}$		3.4						

Ordering Information (Example)

PREFERRED P/N	PACKAGE CODE	UNIT WEIGHT(g)	MINIMUM PACKAGE(pcs)	INNER BOX QUANTITY(pcs)	OUTER CARTON QUANTITY(pcs)	DELIVERY MODE
KBJ6005~KBJ610	B1	Approximate 4.27	20	1000	2000	Tube

Characteristics(Typical)

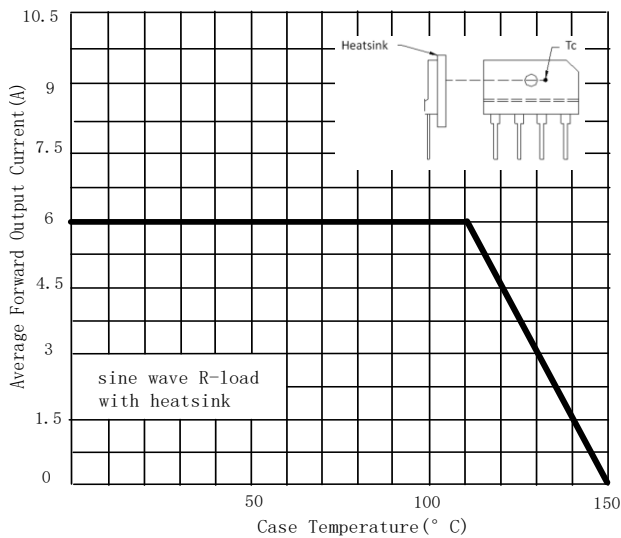
 FIG1: I_o - T_c Curve


FIG2: Surge Forward Current Capability

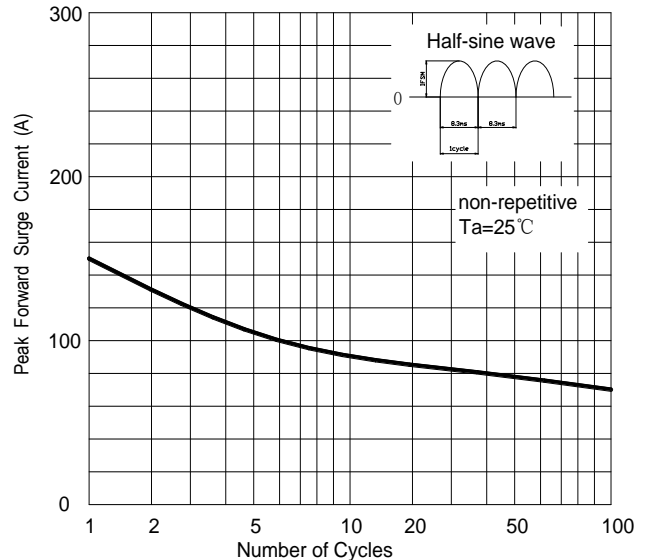


FIG3: Instantaneous Forward Voltage

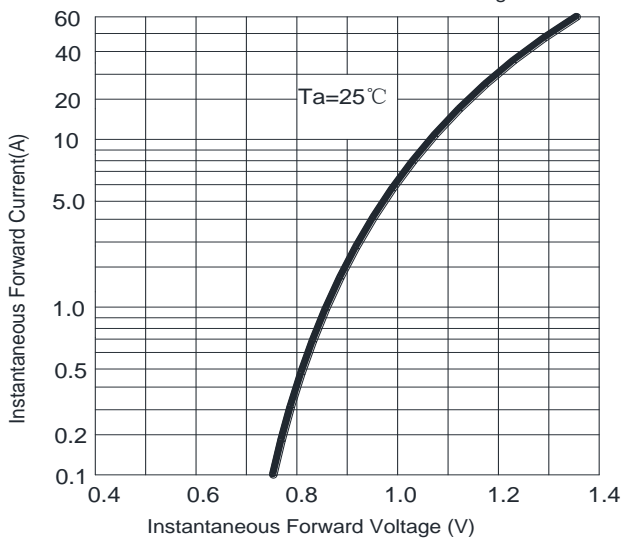
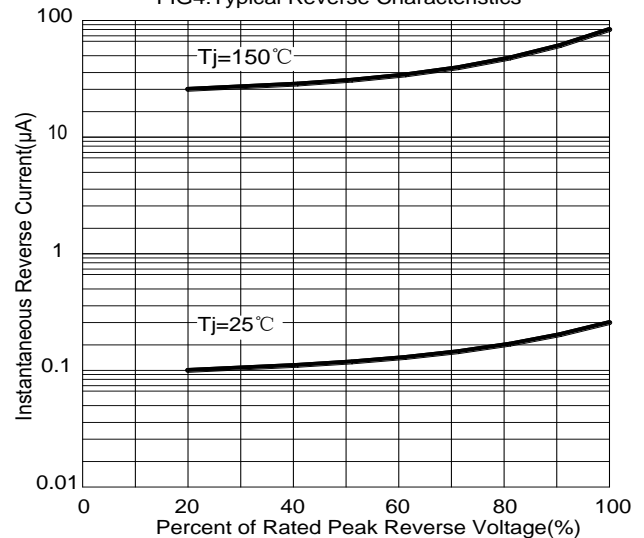
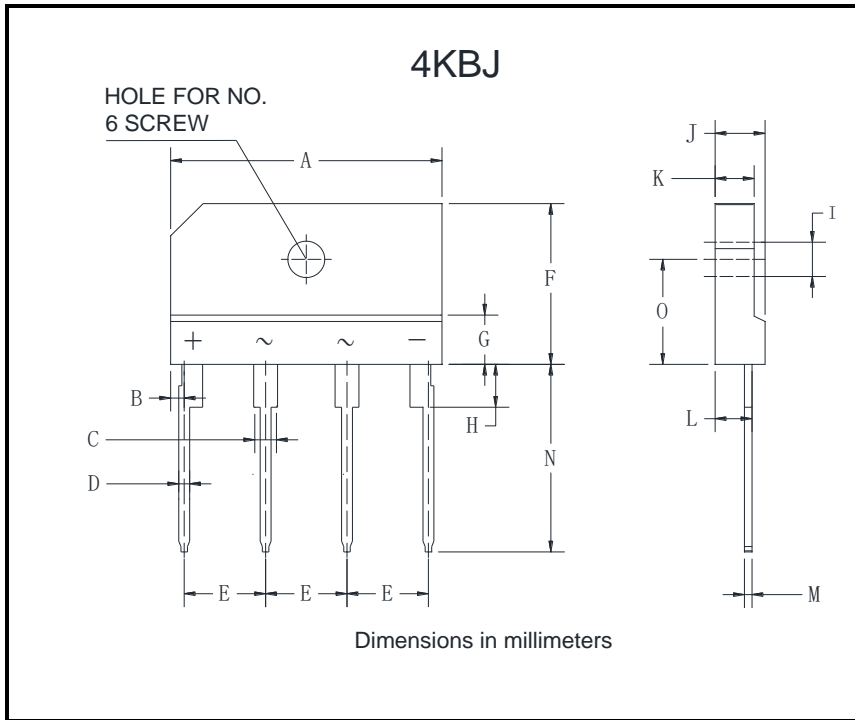


FIG4: Typical Reverse Characteristics



■ Outline Dimensions


4KBJ		
Dim	Min	Max
A	24.7	25.3
B	1.05	1.45
C	1.7	2.1
D	0.9	1.1
E	7.3	7.7
F	14.7	15.3
G	3.8	4.2
H	3.3	3.7
I	3.1	3.4
J	4.4	4.8
K	3.4	3.8
L	3.2	3.4
M	0.6	0.8
N	17.0	18.0
O	9.5	10.1