

- ★ 100% EAS Guaranteed
- ★ Green Device Available
- ★ Super Low Gate Charge
- ★ Excellent CdV/dt effect decline
- ★ Advanced high cell density Trench technology



Product Summary

BVDSS	RDS(on)	ID
60V	8 mΩ	65A

Description

The XXWS65N06F is the high cell density trenched N-ch MOSFETs, which provide excellent RDS(on) and gate charge for most of the synchronous buck converter applications.

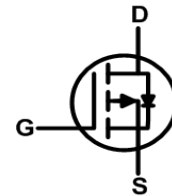
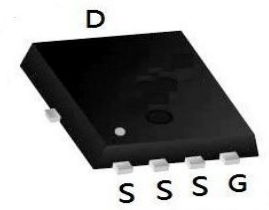
The XXWS65N06F meet the RoHS and Green Product requirement, 100% EAS guaranteed with full function reliability approved.

PRPAK5X6 Pin Configuration

Absolute Maximum Ratings ($T_C=25^\circ\text{C}$ unless otherwise specified)

Symbol	Parameter	Max.	Units
V_{DSS}	Drain-Source Voltage	60	V
V_{GSS}	Gate-Source Voltage	± 20	V
I_D	Continuous Drain Current	$T_C = 25^\circ\text{C}$	65
		$T_C = 100^\circ\text{C}$	49
I_{DM}	Pulsed Drain Current ^{note1}	240	A
E_{AS}	Single Pulsed Avalanche Energy ^{note2}	56	mJ
P_D	Power Dissipation	$T_C = 25^\circ\text{C}$	89
$R_{\theta JC}$	Thermal Resistance, Junction to Case	2.5	$^\circ\text{C}/\text{W}$
T_J, T_{STG}	Operating and Storage Temperature Range	-55 to +175	$^\circ\text{C}$

Electrical Characteristics ($T_J=25^\circ\text{C}$ unless otherwise specified)

Symbol	Parameter	Test Condition	Min.	Typ.	Max.	Units
Off Characteristic						
$V_{(BR)DSS}$	Drain-Source Breakdown Voltage	$V_{GS}=0V, I_D=250\mu A$	60	-	-	V
I_{DSS}	Zero Gate Voltage Drain Current	$V_{DS}=60V, V_{GS}=0V,$	-	-	1.0	μA
I_{GSS}	Gate to Body Leakage Current	$V_{DS}=0V, V_{GS}=\pm 20V$	-	-	± 100	nA
On Characteristics						
$V_{GS(th)}$	Gate Threshold Voltage	$V_{DS}=V_{GS}, I_D=250\mu A$	1.0	1.6	2.5	V
$R_{DS(on)}$	Static Drain-Source on-Resistance <small>note3</small>	$V_{GS}=10V, I_D=20A$	-	8	11	m Ω
		$V_{GS}=4.5V, I_D=10A$	-	14	20	
Dynamic Characteristics						
C_{iss}	Input Capacitance	$V_{DS}=25V, V_{GS}=0V,$ $f=1.0MHz$	-	930	-	pF
C_{oss}	Output Capacitance		-	370	-	pF
C_{rss}	Reverse Transfer Capacitance		-	20	-	pF
Q_g	Total Gate Charge	$V_{DS}=30V, I_D=20A,$ $V_{GS}=10V$	-	19	-	nC
Q_{gs}	Gate-Source Charge		-	4.8	-	nC
Q_{gd}	Gate-Drain("Miller") Charge		-	4.5	-	nC
Switching Characteristics						
$t_{d(on)}$	Turn-on Delay Time	$V_{DD}=30V, I_D=20A,$ $R_G=1.6\Omega, V_{GS}=10V$	-	4.9	-	ns
t_r	Turn-on Rise Time		-	31	-	ns
$t_{d(off)}$	Turn-off Delay Time		-	23	-	ns
t_f	Turn-off Fall Time		-	8.7	-	ns
Drain-Source Diode Characteristics and Maximum Ratings						
I_S	Maximum Continuous Drain to Source Diode Forward Current		-	-	65	A
I_{SM}	Maximum Pulsed Drain to Source Diode Forward Current		-	-	240	A
V_{SD}	Drain to Source Diode Forward Voltage	$V_{GS}=0V, I_S=30A$	-	-	1.4	V
t_{rr}	Body Diode Reverse Recovery Time	$T_J=25^\circ\text{C},$ $I_F=20A, di/dt=100A/\mu s$	-	34	-	ns
Q_{rr}	Body Diode Reverse Recovery Charge		-	14	-	nC

Notes:1. Repetitive Rating: Pulse Width Limited by Maximum Junction Temperature

2. EAS condition: $T_J=25^\circ\text{C}, V_{DD}=30V, V_G=10V, R_G=25\Omega, L=0.5mH, I_{AS}=12A$

3. Pulse Test: Pulse Width $\leq 300\mu s$, Duty Cycle $\leq 0.5\%$

Typical Performance Characteristics

Figure 1: Output Characteristics

Figure 2: Typical Transfer Characteristics

Figure 3: On-resistance vs. Drain Current

Figure 4: Body Diode Characteristics

Figure 5: Gate Charge Characteristics

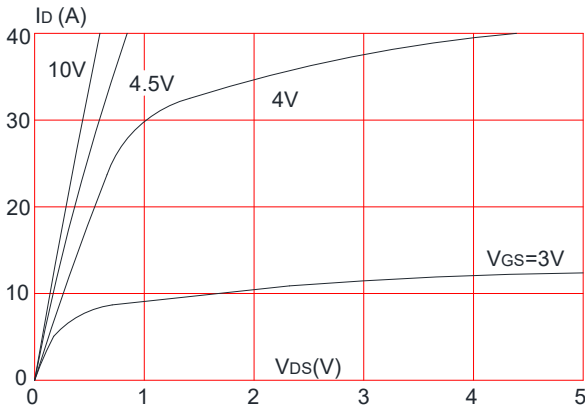
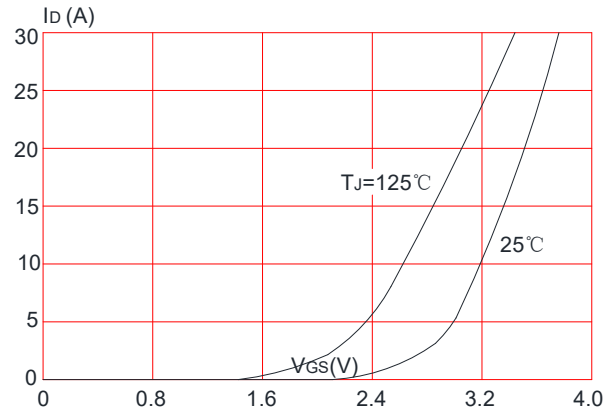
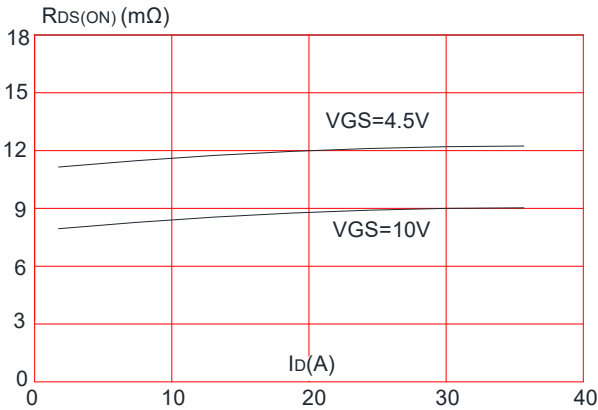
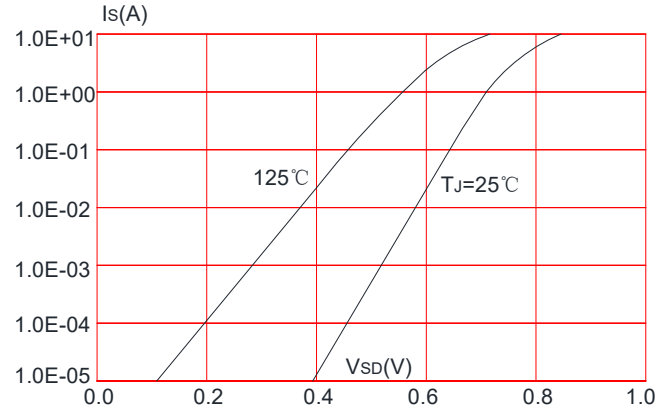
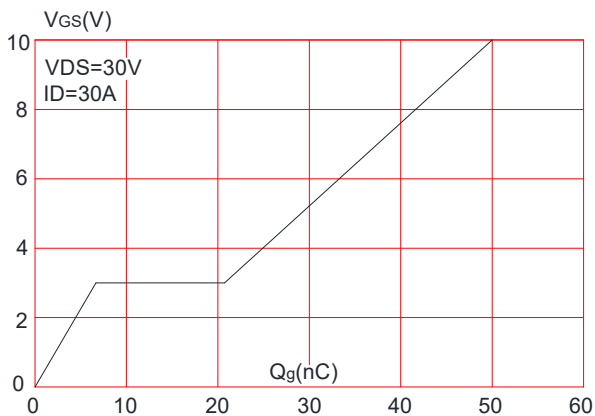
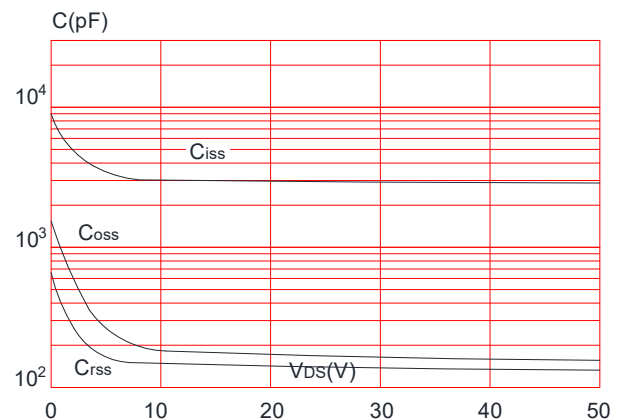
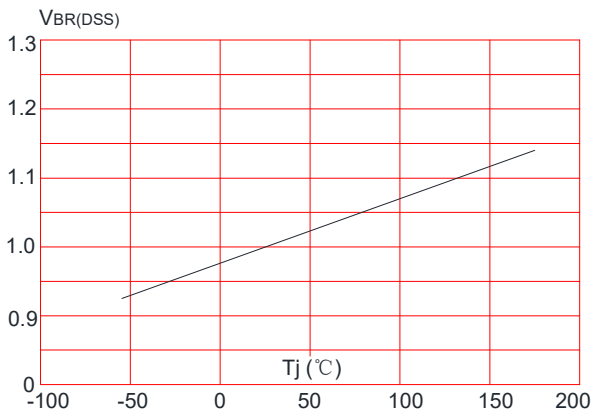
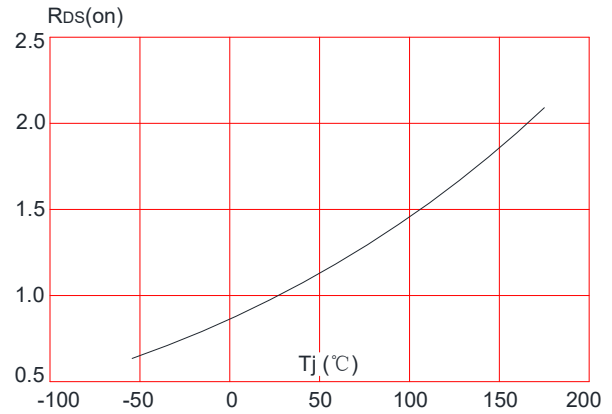
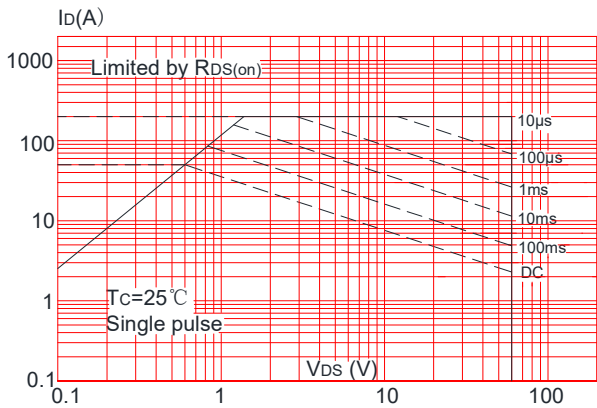
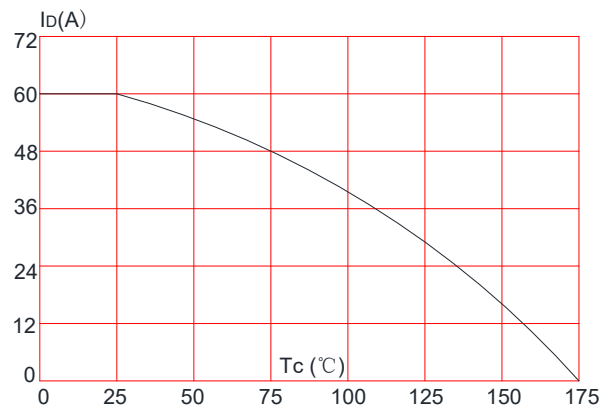
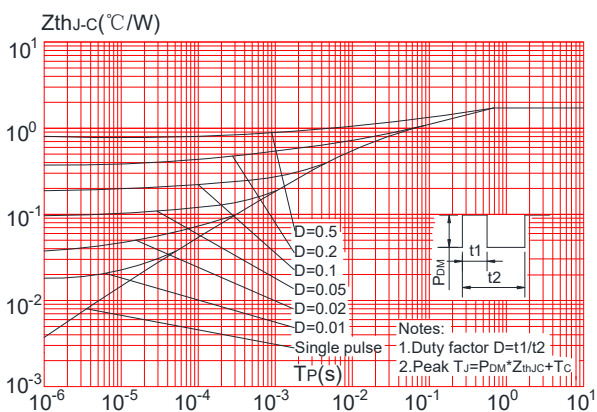
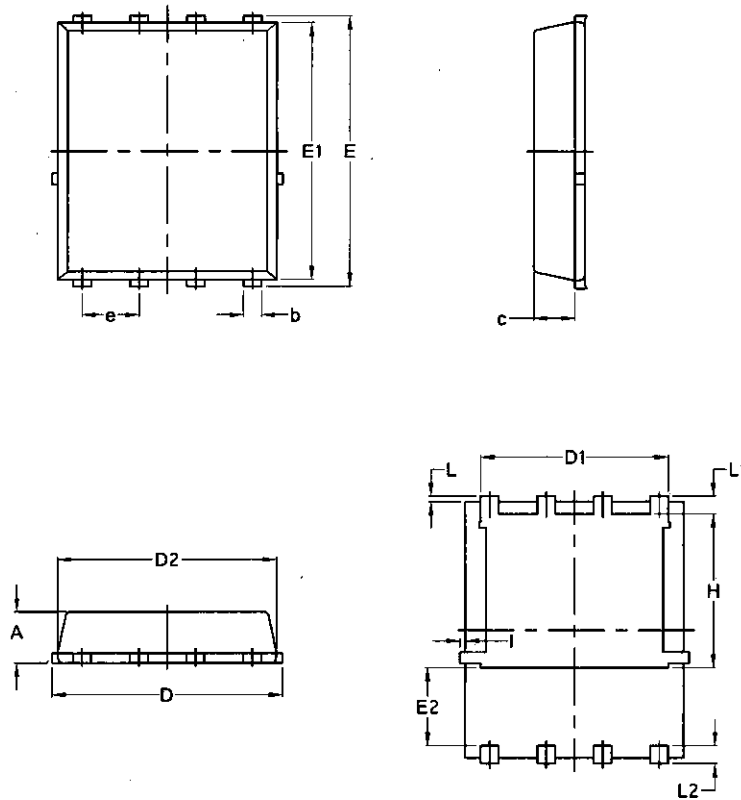
Figure 6: Capacitance Characteristics

Figure 7: Normalized Breakdown Voltage vs. Junction Temperature

Figure 8: Normalized on Resistance vs. Junction Temperature

Figure 9: Maximum Safe Operating Area

Figure 10: Maximum Continuous Drain Current vs. Case Temperature

Figure.11: Maximum Effective Transient Thermal Impedance, Junction-to-Case

Package Mechanical Data-DFN5*6-8L-JQ Single

Symbol	Common			
	mm		Inch	
	Mim	Max	Min	Max
A	1.03	1.17	0.0406	0.0461
b	0.34	0.48	0.0134	0.0189
c	0.824	0.0970	0.0324	0.082
D	4.80	5.40	0.1890	0.2126
D1	4.11	4.31	0.1618	0.1697
D2	4.80	5.00	0.1890	0.1969
E	5.95	6.15	0.2343	0.2421
E1	5.65	5.85	0.2224	0.2303
E2	1.60	/	0.0630	/
e	1.27 BSC		0.05 BSC	
L	0.05	0.25	0.0020	0.0098
L1	0.38	0.50	0.0150	0.0197
L2	0.38	0.50	0.0150	0.0197
H	3.30	3.50	0.1299	0.1378
I	/	0.18	/	0.0070